



-7RF Antenna-

7RF-MX2-0004-DLJ1-01



Author: Sam Yang(7RF TW)

Revision: A

Date: 2019/11/12



I. Introduction.

7RF provides external Adhesive/Magnetic Mounted dual LTE antenna solution. P/N: MX2-0004-DLJ1-01 antenna supports LTE MIMO application. The antenna has solid enclosure with Magnet, which assist end user easy to stick antenna on metal surface, also it can choose double sided adhesive foam as option, different mounting options for customer's flavor. The antenna has 3 meters RG174 coaxial cable with SMA male connector as standard configuration. Cable length & Connector are customizable. Contact your local sales to get more product information.

II. Antenna Specification Table

MX2-0004-DLJ1-01	
Electrical Characteristics	
LTE MAIN	
Frequency (MHz)	698-960, 1710-2690
Return Loss (dB)	<-6
Peak Gain (dBi)	2.50 Typ.
Polarization	Linear
LTE AUX	
Frequency (MHz)	698-960, 1710-2690
Return Loss (dB)	<-6
Peak Gain (dBi)	2.00 Typ.
Polarization	Linear
Mechanical Characteristics	
Dimension (mm)	73* 64.1 * 14
Cable & Length	RG174, 3 meters
Connector	SMA Male
Housing Material	ABS
Mounting Method	Adhesive/Magnetic
Storage Temperature (°C)	-40~+85
Operate Temperature (°C)	-40~+85



III. Antenna 2D Radiation Pattern



LTE Antenna MAIN

XY-PLANE

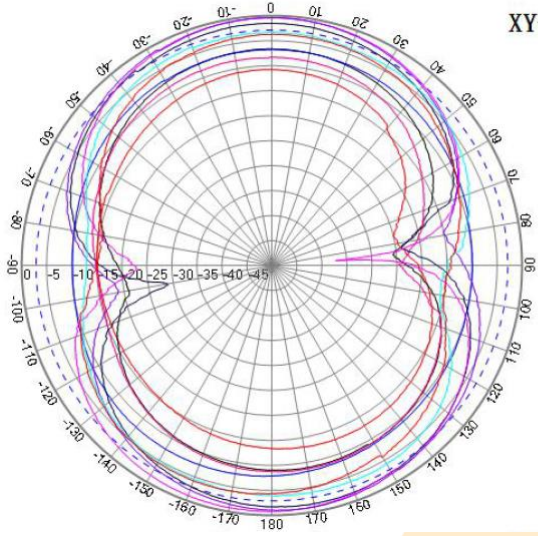

- Freq: 698
- Freq: 824
- Freq: 868
- Freq: 960
- Freq: 1710
- Freq: 1850
- Freq: 1990
- Freq: 2170
- Freq: 2690

XZ-PLANE

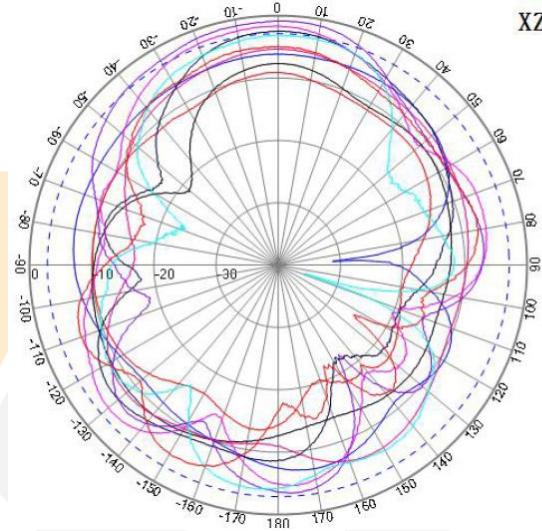

- Freq: 698
- Freq: 824
- Freq: 868
- Freq: 960
- Freq: 1710
- Freq: 1850
- Freq: 1990
- Freq: 2170
- Freq: 2690

YZ-PLANE

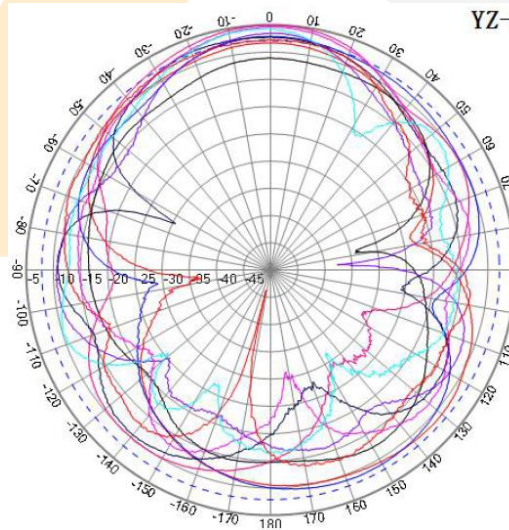

- Freq: 698
- Freq: 824
- Freq: 868
- Freq: 960
- Freq: 1710
- Freq: 1850
- Freq: 1990
- Freq: 2170
- Freq: 2690

LTE Antenna AUX

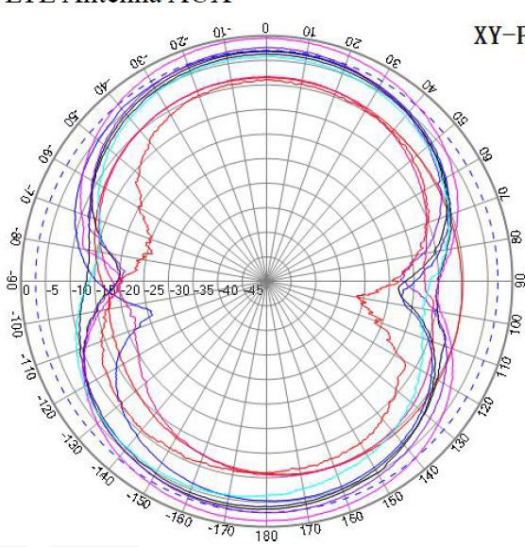

- Freq: 698
- Freq: 824
- Freq: 868
- Freq: 960
- Freq: 1710
- Freq: 1850
- Freq: 1990
- Freq: 2170
- Freq: 2690

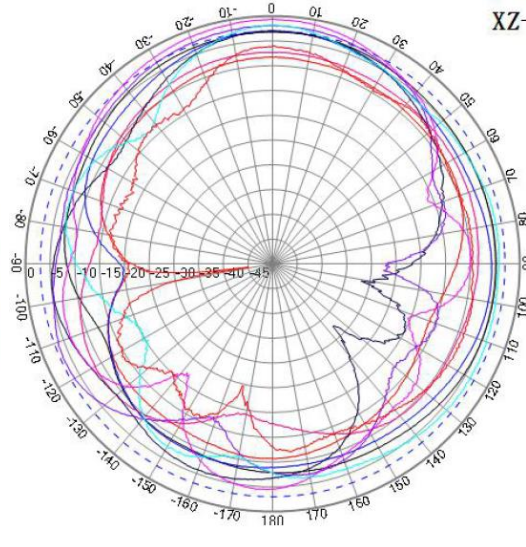

- Freq: 698
- Freq: 824
- Freq: 868
- Freq: 960
- Freq: 1710
- Freq: 1850
- Freq: 1990
- Freq: 2170
- Freq: 2690

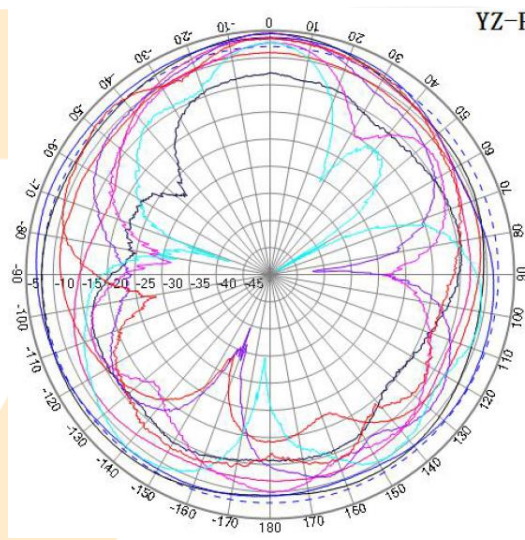

- Freq: 698
- Freq: 824
- Freq: 868
- Freq: 960
- Freq: 1710
- Freq: 1850
- Freq: 1990
- Freq: 2170
- Freq: 2690

IV. Antenna Drawing

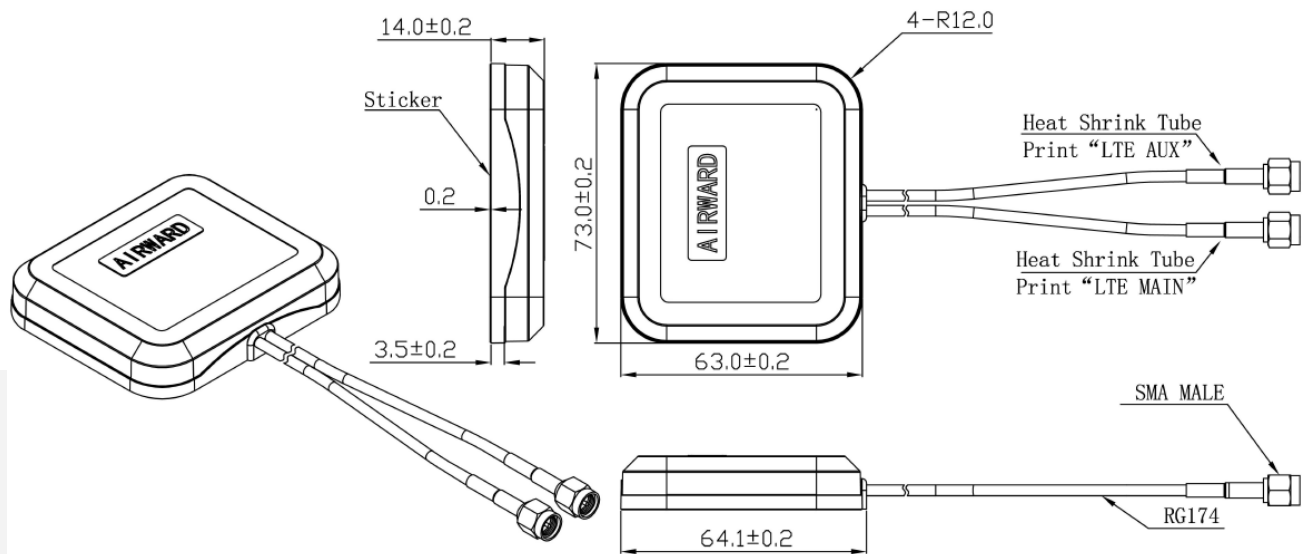

Unit:mm

Cable Length: 3000+/-80mm